

MIBOXER[®]

Mi • Light Subordinate New Brand

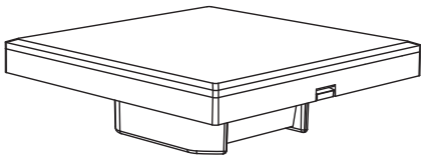

0~10V Panel Dimmer

Model No.: L1 / L4

Product Features

Exquisite fashionable stalinite Panel; Adopt high precision touching IC with more sensitive and stable touching. Touch the slider to output 0~10V signal, and working with 0/1~10V Dimming Diver; Brightness dimmable; Widely work on the controlling of hotel lighting and home lighting.

Technical Parameters

Input Voltage: AC100~240V 50/60Hz

Output Voltage: 0~10V

Output Current: Max. 20mA/Channel

Working Temperature: -20~60°C

Size: 86*86*28mm

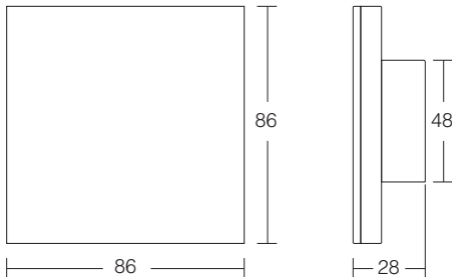

Product Features

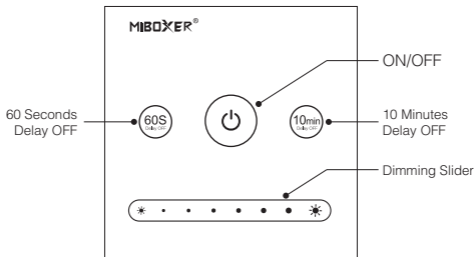

Model No.: L1

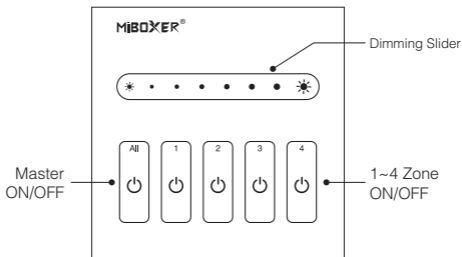

Model No.: L4



When the light is ON, Press “ 60S ”, indicating lamp will blink quickly, the light will be off automatically after 60 seconds; Touch again to cancel **"60S Delay OFF"** function



When the light is ON, Press “ 10min ”, indicating lamp will blink slowly, the light will be off automatically after 10 Minutes; Touch again to cancel **"10min Delay OFF"** function



256 grade brightness dimming

Connection Diagram

L1 One Channel Panel Dimmer

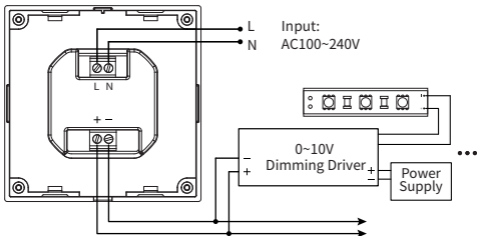

L4 Four Channel Panel Dimmer

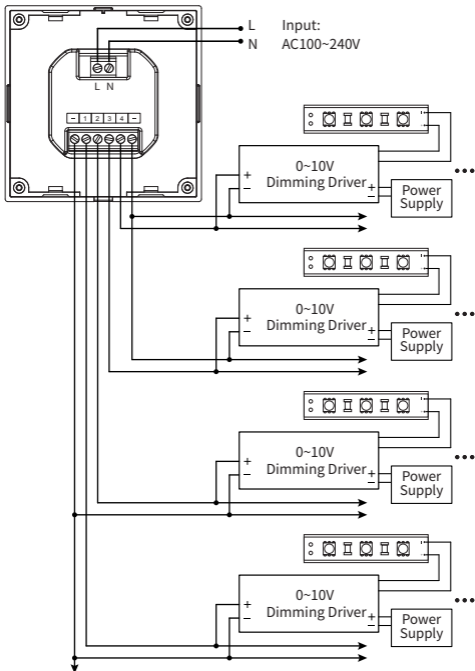

Installation / Dismantlement

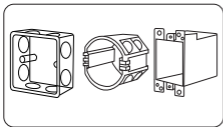

Install the bottom case into the wall; Above are the standard bottom cases.

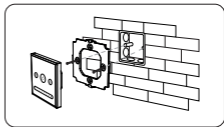

Fix the panel dimmer base on the bottom case with screw.

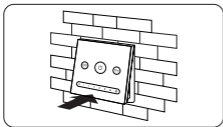

Clicks into the upper side of panel dimmer base, then press the lower side slightly to make it clicks into the base.

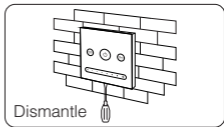

Plug into the below bayonet with a screwdriver, and upward screwdriver, then you can dismantle the controller.

Attention:

1. Before installation, pls check the input voltage is same as the Panel Dimmer, and check the connection of polarity.
2. When Installation, pls handle with care to avoid the broken of the glass panel.



Made in China